

RKK Series ◊ Regulated SIP7

1W ◊ Isolated Single Output ◊ 1:1 Input

FEATURES

- Low cost
- 1:1 input voltage range
- Efficiency up to 82%
- 4kVDC/1 second isolation
- IEC/EN/UL 62368-1 certified
- -40°C to +105°C operating temperature range
- 3 year warranty

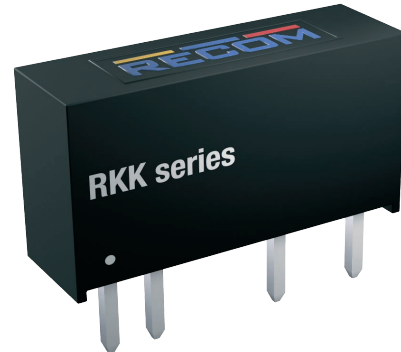

Dimensions (LxWxH): 19.6 x 6.0 x 10.2mm (0.77 x 0.24 x 0.4inch)
1.7g (0.004lbs)

APPLICATIONS

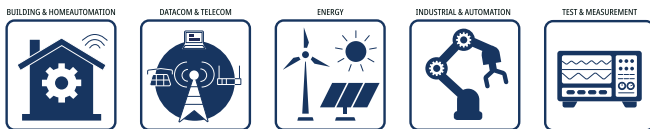

SAFETY & EMC



DESCRIPTION

The RKK DC/DC converters are typically used in cost sensitive general purpose power isolation and voltage matching applications. Despite their low cost, they are fully specified converters with 4kVdc isolation, industrial operating temperature range of -40°C to +105°C without derating and UL/EN certifications.

SELECTION GUIDE 2:1 INPUT

Part Number	Input Voltage [VDC]	Output Voltage [VDC]	Output Current [mA]	Efficiency typ. ⁽¹⁾ [%]	max. Capacitive Load ⁽²⁾ [µF]
RKK-0505S/H	5	5	200	82	3000

Note1: Efficiency is tested at minimum input and full load at +25°C ambient

Note2: Max Cap Load is tested at nominal input an full resistive load

MODEL NUMBERING



RKK Series \diamond Regulated SIP7

1W \diamond Isolated Single Output \diamond 1:1 Input

BASIC CHARACTERISTICS (measured @ $T_{AMB} = 25^{\circ}C$, nom. V_{IN} , full load and after warm-up unless otherwise stated)

Parameter	Conditions	Min.	Typ.	Max.
Internal Input Filter				internal capacitors
Input Voltage Range			$\pm 10\%$	
Absolute Maximum Input Voltage ⁽³⁾				6VDC
Input Current				240mA
Minimum Load		0%		
Start-up Time				50ms
Internal Operating Frequency				1MHz
Output Ripple and Noise ⁽⁴⁾	20MHz BW		60mVp-p	

Note3: An $4.7\mu F/10V$ MLCC at input terminal is recommended if transient input voltage above 6VDC

Note4: Measurements are made with a $0.1\mu F$ MLCC across output. (low ESR)

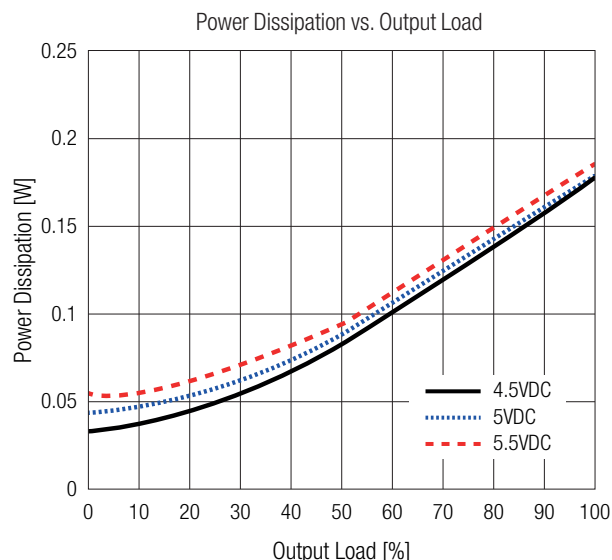
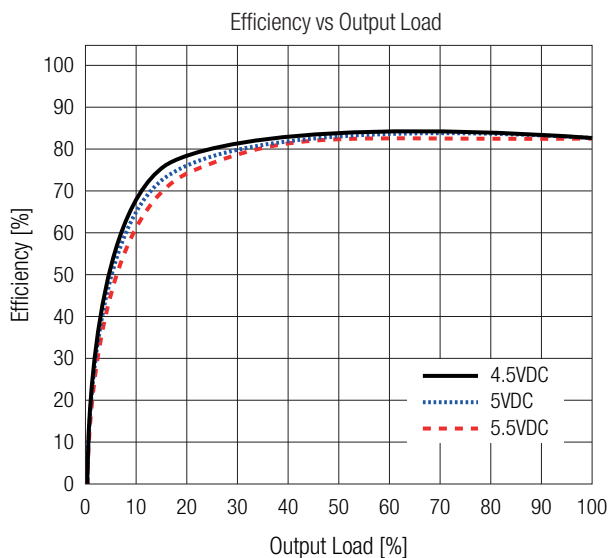

REGULATIONS

Parameter	Conditions	Value
Output Accuracy		$\pm 5.0\%$ max.
Line Regulation	low line to high line, full load	$\pm 2.0\%$ max.
Load Regulation ⁽⁵⁾	0%-100% full load	10% typ., 13% max.
	10%-100% full load	7.0% max.

Note5: Operation below 10% load will not harm the converter, but specifications may not be met

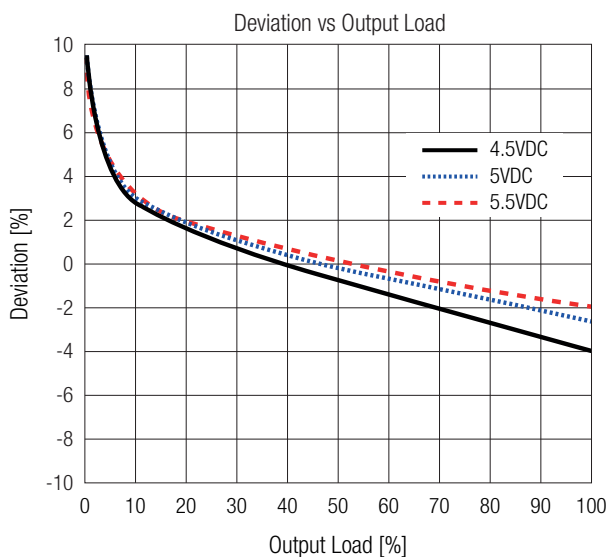

RKK Series \diamond Regulated SIP7

1W \diamond Isolated Single Output \diamond 1:1 Input

PROTECTIONS

Parameter	Conditions		Value
Short Circuit Protection (SCP)	below 100m Ω		auto recovery
Isolation Voltage ⁽⁶⁾	I/P to O/P	1 second	4kVDC
		1 minute	3kVDC
Isolation Resistance	I/P to O/P, V _{ISO} = 500VDC		1G Ω min.
Isolation Capacitance	I/P to O/P, 100kHz/0.1V		10pF typ.
Insulation Grade	according to 62368-1		functional

Note6: For repeat Hi-Pot testing, reduce the time and/or the test voltage

ENVIRONMENTAL

Parameter	Conditions		Value
Operating Temperature Range	@ natural convection 0.1m/s, refer to „Derating Graph“		-40°C to +105°C
Maximum Case Temperature			+120°C
Operating Altitude	according to 62368-1		5000m
Operating Humidity	non-condensing		95% RH max.
MTBF	according to MIL-HDBK-217F, G.B.	T _{AMB} = +85°C	2362 x 10 ³ hours

Derating Graph

(@ Chamber and natural convection 0.1m/s)

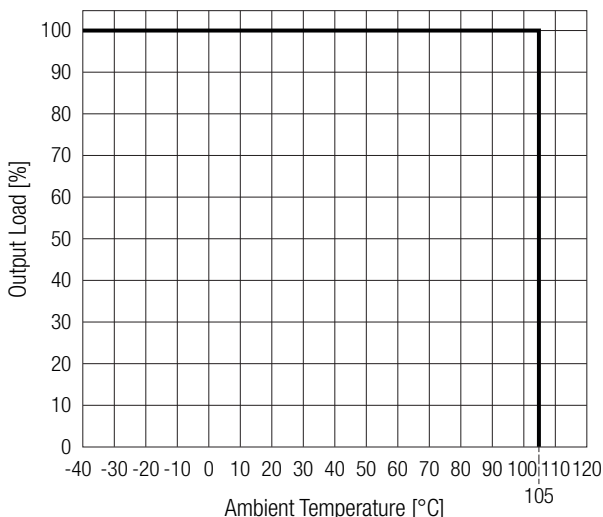

SAFETY & CERTIFICATIONS

Certificate Type (Safety)	Report Number	Standard
Audio/video, information and communication technology equipment - Safety requirements	E518942-A6001-UL	UL62368-1:2014 2nd Ed. CAN/CSA-C22.2 No. 62368-1-14 2nd Ed.
Audio/Video, information and communication technology equipment - Part1: Safety requirements (CB)	E518942-A6001-CB-1	IEC62368-1:2014 2nd Ed.
Audio/Video, information and communication technology equipment - Part1: Safety requirements		EN62368-1:2014 + A11:2017
RoHS2		RoHS 2011/65/EU + AM2015/863

EMC Compliance	Conditions	Standard / Criterion
Electromagnetic compatibility of multimedia equipment – Emission Requirements	with external filter, refer to below filter suggestion	EN55032, Class A
		EN55032, Class B

EMC filter suggestion

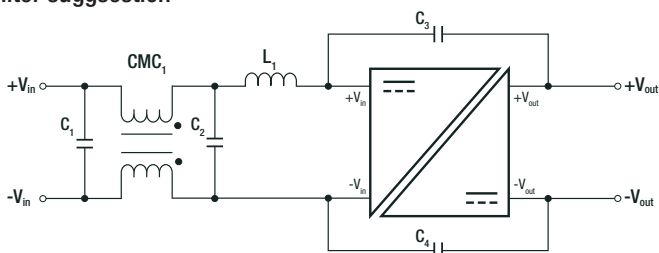

Component List Class A

C2	L1	C3, C4
10 μ F	22 μ H, RLS-226	470pf

Component List Class B

C1, C2	CMC1	L1	C3, C4
10 μ F	9 μ H	22 μ H, RLS-226	470pf

RKK Series \diamond Regulated SIP7

1W \diamond Isolated Single Output \diamond 1:1 Input

DIMENSION & PHYSICAL CHARACTERISTICS

Parameter	Type	Value
Material	case	black plastic, (UL94 V-0)
	PCB	FR4, (UL94 V-0)
Dimension (LxWxH)		19.6 x 6.0 x 10.2mm 0.77 x 0.24 x 0.4 inch
Weight		1.7g typ. 0.004 lbs

Dimension Drawing (mm)

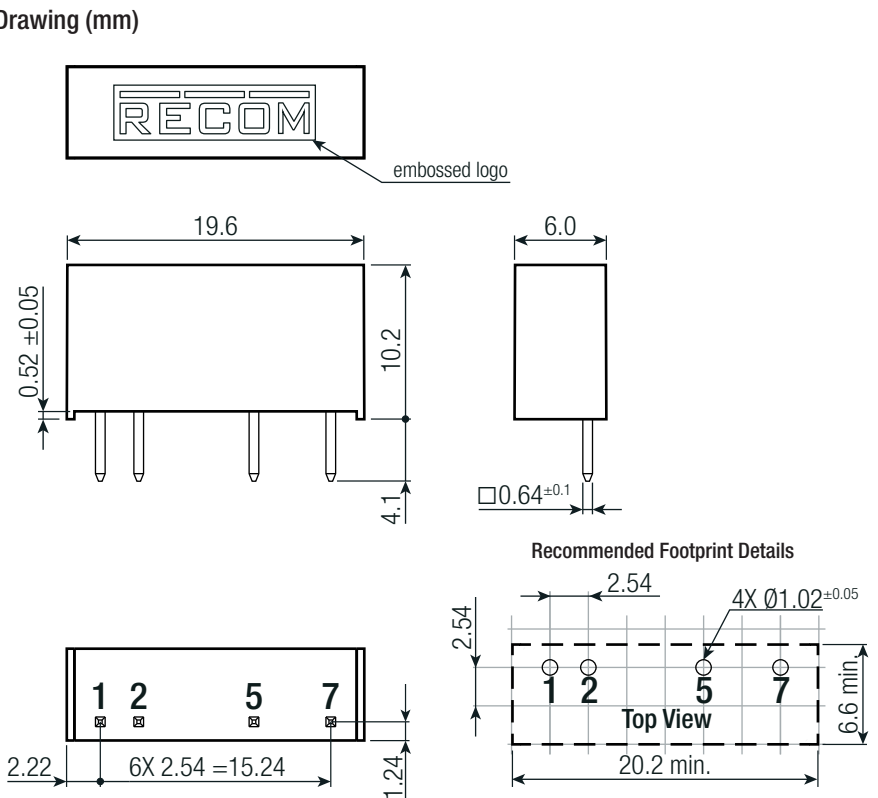

Pinning Information

Pin #	Single
1	+Vin
2	-Vin
5	-Vout
7	+Vout

Tolerance:
xx.x = ± 0.5 mm
xx.xx = ± 0.25 mm

PACKAGING INFORMATION

Parameter	Type	Value
Packaging Dimension (LxWxH)	tube	520.0 x 9.2 x 19.0mm
Packaging Quantity		25pcs
Storage Temperature Range		-50°C to +125°C
Storage Humidity	non-condensing	95% RH max.

The product information and specifications may be subject to changes even without prior written notice. The product has been designed for various applications; its suitability lies in the responsibility of each customer. The products are not authorized for use in safety-critical applications without RECOM's explicit written consent. A safety-critical application is an application where a failure may reasonably be expected to endanger or cause loss of life, inflict bodily harm or damage property. The applicant shall indemnify and hold harmless RECOM, its affiliated companies and its representatives against any damage claims in connection with the unauthorized use of RECOM products in such safety-critical applications.