

2.00mm pitch

IDC – Female Connector

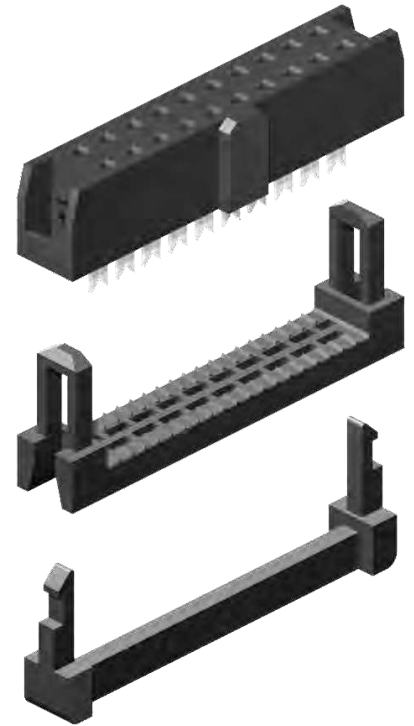
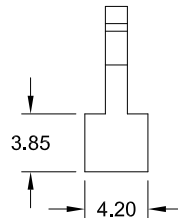
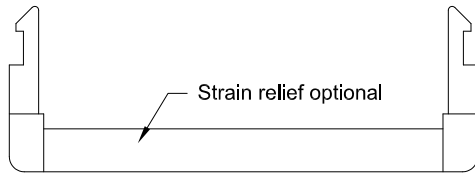
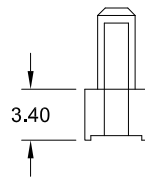
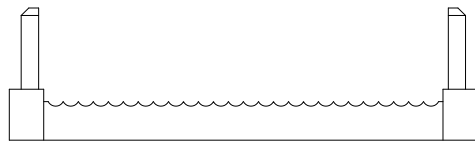
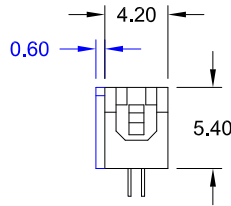
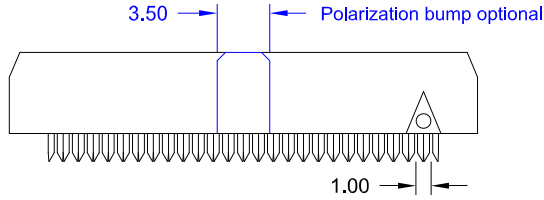
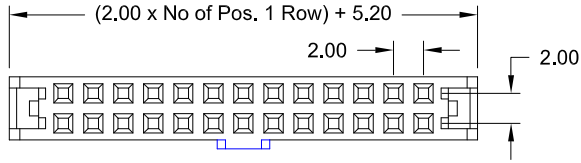

Specifications

Current rating	1 A	Operating temperature	- 40°C to +105°C
Insulation resistance	1000 MΩ min.	Contact material	(RoHS compliant) Copper alloy
Contact resistance	15 mΩ max.	Insulator material	(RoHS compliant) PBT (black) UL 94 V-0
Withstanding voltage	500 V AC		

Application and Features

Designed to mate with 0.50mm square pins Box Header

High Quality dual beam contacts

Accepts 26 & 28 AWG 1.00mm flat ribbon cable.

How to order

IDS - xxx - X 200 - N5 (/P)

